

# YAMAHA

# RX-485 RDS/385/385 RDS

*Natural Sound Stereo Receiver*

*Ampli-syntoniseur stéréo de la série "Natural Sound"*

*Natural Sound Stereoreceiver*

*Natural Sound Stereoreceiver*

*Ricevitore stereo a suono naturale*

*Receptor estéreo de Sonido Natural*

*Natural Sound Stereo Ontvanger*

OWNER'S MANUAL  
MODE D'EMPLOI  
BEDIENUNGSANLEITUNG  
BRUKSANVISNING  
MANUALE DI ISTRUZIONI  
MANUAL DE INSTRUCCIONES  
GEBRUIKSAANWIJZING

**SUPPLIED ACCESSORIES**  
**ACCESSOIRES FOURNIS**  
**MITGELIEFERTE ZUBEHÖRTEILE**  
**MEDFÖLJANDE TILLBEHÖR**  
**ACCESSORI IN DOTAZIONE**  
**ACCESORIOS INCLUIDOS**  
**BIJGELEVERDE ACCESSOIRES**

- After unpacking, check that the following parts are contained.
- Après le déballage, vérifiez que les pièces suivantes sont incluses.
- Nach dem Auspacken überprüfen, ob die folgenden Teile vorhanden sind.
- Kontrollera efter det apparaten packats upp att följande delar finns med.
- Verificare che tutte le parti seguenti siano contenute nell'imballaggio dell'apparecchio.
- Desembale el aparato y verifique que los siguientes accesorios están en la caja.
- Controleer na het uitpakken of de volgende onderdelen voorhanden zijn.

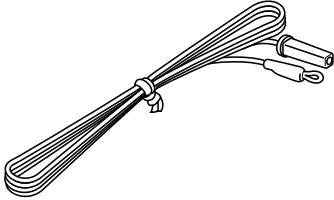
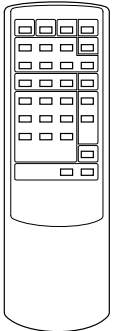
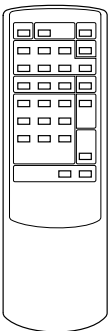
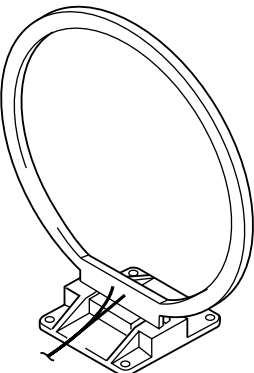
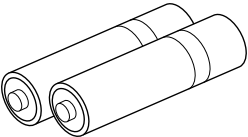
<ul style="list-style-type: none"> <li>• Indoor FM Antenna</li> <li>• Antenne FM intérieure</li> <li>• UKW-Innenantenne</li> <li>• FM inomhusantenn</li> <li>• Antenna FM per interni</li> <li>• Antena FM interior</li> <li>• FM Binnenantenne</li> </ul> 	<ul style="list-style-type: none"> <li>• Remote Control Transmitter</li> <li>• Emetteur de télécommande</li> <li>• Fernbedienungsgeber</li> <li>• Fjärrkontrollsändare</li> <li>• Telecomando</li> <li>• Transmisor del control remoto</li> <li>• Afstandbediening</li> </ul> <div style="display: flex; justify-content: space-around;"> <div style="text-align: center;"> <p><b>RX-485 RDS</b></p>  </div> <div style="text-align: center;"> <p><b>RX-385, RX-385 RDS</b></p>  </div> </div>
<ul style="list-style-type: none"> <li>• AM Loop Antenna</li> <li>• Antenne AM à boucle</li> <li>• MW-Rahmenantenne</li> <li>• AM ramantenn</li> <li>• Antenna AM ad anello</li> <li>• Antena de cuadro de AM</li> <li>• AM Lusantenne</li> </ul> 	<ul style="list-style-type: none"> <li>• Batteries (size AA, R6, UM-3)</li> <li>• Piles (taille AA, R6, UM-3)</li> <li>• Batterien (größer AA, R6, UM-3)</li> <li>• Batterier (storlek AA, R6, UM-3)</li> <li>• Batterie (dimensioni AA, R6, UM-3)</li> <li>• Pilas (tamaño AA, R6, UM-3)</li> <li>• Batterijen (maat AA, R6, UM-3)</li> </ul> 

This product complies with the radio frequency interference requirements of the Council Directive 82/499/EEC and/or 87/308/EEC.

Cet appareil est conforme aux prescriptions de la directive communautaire 87/308/CEE.

Diese Geräte entsprechen der EG-Richtlinie 82/499/EWG und/oder 87/308/EWG.

Denne apparat overholder det gældende EF-direktiv vedrørende radiostøj.

Questo apparecchio è conforme al D.M.13 aprile 1989 (Direttiva CEE/87/308) sulla soppressione dei radiodisturbi.

Este producto está de acuerdo con los requisitos sobre interferencias de radio frecuencia fijados por el Consejo Directivo 87/308 CEE.

Dit product voldoet aan de EEG normen betreffende radio-frekventie storingen 82/499/EEG en/of 87/308/EEG.

## FEATURES

- **RX-485 RDS**  
65W + 65W (8Ω) RMS Output Power,  
0.04% THD, 20 – 20,000 Hz
- **RX-385 and RX-385 RDS**  
40W + 40W (8Ω) RMS Output Power,  
0.04% THD, 20 – 20,000 Hz
- High Dynamic Power, Low Impedance Drive Capability
- Continuously Variable Loudness Control
- 40-Station Random Preset Tuning
- Automatic Preset Tuning
- Preset Station Shifting Capability
- IF Count Direct PLL Synthesizer Tuning System
- Remote Control Capability
- **RX-485 RDS and RX-385 RDS only**
- Multi-Functions for RDS Broadcast Reception
- **RX-485 RDS only**
- Pure Direct Switch to Reproduce the Purest Source Sound

## CONTENTS

Supplied Accessories .....	2	Remote Control Transmitter .....	21
Caution .....	4	Notes about the Remote Control Transmitter .....	22
Connections .....	5	Troubleshooting .....	23
Operations .....	9	Specifications .....	24
Tuning Operations .....	12		
Preset tuning .....	13		
Receiving RDS Stations			
<b>RX-485 RDS and RX-385 RDS only</b> .....	16		

### How to Use This Manual

This manual describes three YAMAHA receivers, RX-385, RX-385 RDS and RX-485 RDS. There are some differences between those three models. Especially, RX-385 RDS and RX-485 RDS contain the functions for receiving special data on RDS network stations.

RX-385, on the other hand, is a receiver with a usual FM/AM tuning function.

Several places in the manual refer to differences in features between the three models. Be sure to follow the procedure for the model you are using.

\* RDS is a data transmitting service system in network which is employed by FM stations. RDS stations are increasing in many countries (especially in Europe).

## CAUTION: READ THIS BEFORE OPERATING YOUR UNIT.

1. To assure the finest performance, please read this manual carefully. Keep it in a safe place for future reference.
2. Install this unit in a cool, dry, clean place – away from windows, heat sources, sources of excessive vibration, dust, moisture and cold. Avoid sources of humming (transformers, motors). To prevent fire or electrical shock, do not expose the unit to rain or water.
3. Never open the cabinet. If something drops into the set, contact your dealer.
4. Do not use force on switches, controls or connection wires. When moving the unit, first disconnect the power plug and the wires connected to other equipment. Never pull the wires themselves.
5. The openings on the cabinet assure proper ventilation of the unit. If these openings are obstructed, the temperature inside the cabinet will rise rapidly and eventually damage the circuits. Therefore, avoid placing objects against these openings and do not install the unit where the flow of air through the ventilation openings could be impeded.
6. Always set the VOLUME control to “– ∞” before starting the audio source play. Increase the volume gradually to an appropriate level after playback has been started.
7. Do not attempt to clean the unit with chemical solvents; this might damage the finish. Use a clean, dry cloth.
8. Be sure to read the “TROUBLESHOOTING” section regarding common operating errors before concluding that the unit is faulty.
9. When not planning to use this unit for long periods of time (ie., vacation, etc.), disconnect the AC power plug from the wall outlet.
10. To prevent lightning damage, disconnect the AC power plug and disconnect the antenna cable when there is an electrical storm.
11. Grounding or polarization – Precautions should be taken so that the grounding or polarization of an appliance is not defeated.
12. AC outlet  
Do not connect audio equipment to the AC outlet on the rear panel if that equipment requires more power than the outlet is rated to provide.
13. **Voltage Selector (General Model only)**  
**The voltage selector on the rear panel of this unit must be set for your local main voltage BEFORE plugging into the AC main supply.**  
**Voltages are 110/120/220/240V AC, 50/60 Hz.**

### IMPORTANT

Please record the serial number of this unit in the space below.

Serial No.:

The serial number is located on the rear of the unit. Retain this Owner's Manual in a safe place for future reference.

### WARNING

TO REDUCE THE RISK OF FIRE OR ELECTRIC SHOCK, DO NOT EXPOSE THIS UNIT TO RAIN OR MOISTURE.

### CAUTION (FOR CANADA MODEL)

TO PREVENT ELECTRIC SHOCK, MATCH WIDE BLADE OF PLUG TO WIDE SLOT AND FULLY INSERT.

### FOR CANADIAN CUSTOMER

THIS DIGITAL APPARATUS DOES NOT EXCEED THE “CLASS B” LIMITS FOR RADIO NOISE EMISSIONS FROM DIGITAL APPARATUS SET OUT IN THE RADIO INTERFERENCE REGULATION OF THE CANADIAN DEPARTMENT OF COMMUNICATIONS.

The apparatus is not disconnected from the AC power source as long as it is connected to the wall outlet, even if the apparatus itself is turned off.

### For U.K. customers

If the socket outlets in the home are not suitable for the plug supplied with this appliance, it should be cut off and an appropriate 3 pin plug fitted. For details, refer to the instructions described below.

**Note:** The plug severed from the mains lead must be destroyed, as a plug with bared flexible cord is hazardous if engaged in a live socket outlet.

### SPECIAL INSTRUCTIONS FOR U.K. MODEL

#### IMPORTANT:

The wire in the mains lead are coloured in accordance with the following code:

Blue: NEUTRAL

Brown: LIVE

The colours of the wires in the mains lead of this apparatus may not correspond with the coloured markings identifying the terminals in your plug. Proceed as follows: the wire which is coloured BLUE must be connected to the terminal which is marked with the letter N or coloured BLACK. The wire which is coloured BROWN must be connected to the terminal which is marked with the letter L or coloured RED. Making sure that neither core is connected to the earth terminal of the three pin plug.

#### FREQUENCY STEP switch (General Model only)

Because the interstation frequency spacing differs in different areas, set the FREQUENCY STEP switch (located at the rear) according to the frequency spacing in your area.

Before setting this switch, disconnect the AC power plug of this unit from the AC outlet.

## ANTENNA CONNECTIONS

- Each antenna should be connected to the designated terminals correctly, referring to the following figure.
- Both AM and FM indoor antennas are included with this unit. In general, these antennas will probably provide sufficient signal strength. Nevertheless, a properly installed outdoor antenna will give clearer reception than an indoor one. If you experience poor reception quality, an outdoor antenna may result in improvement.

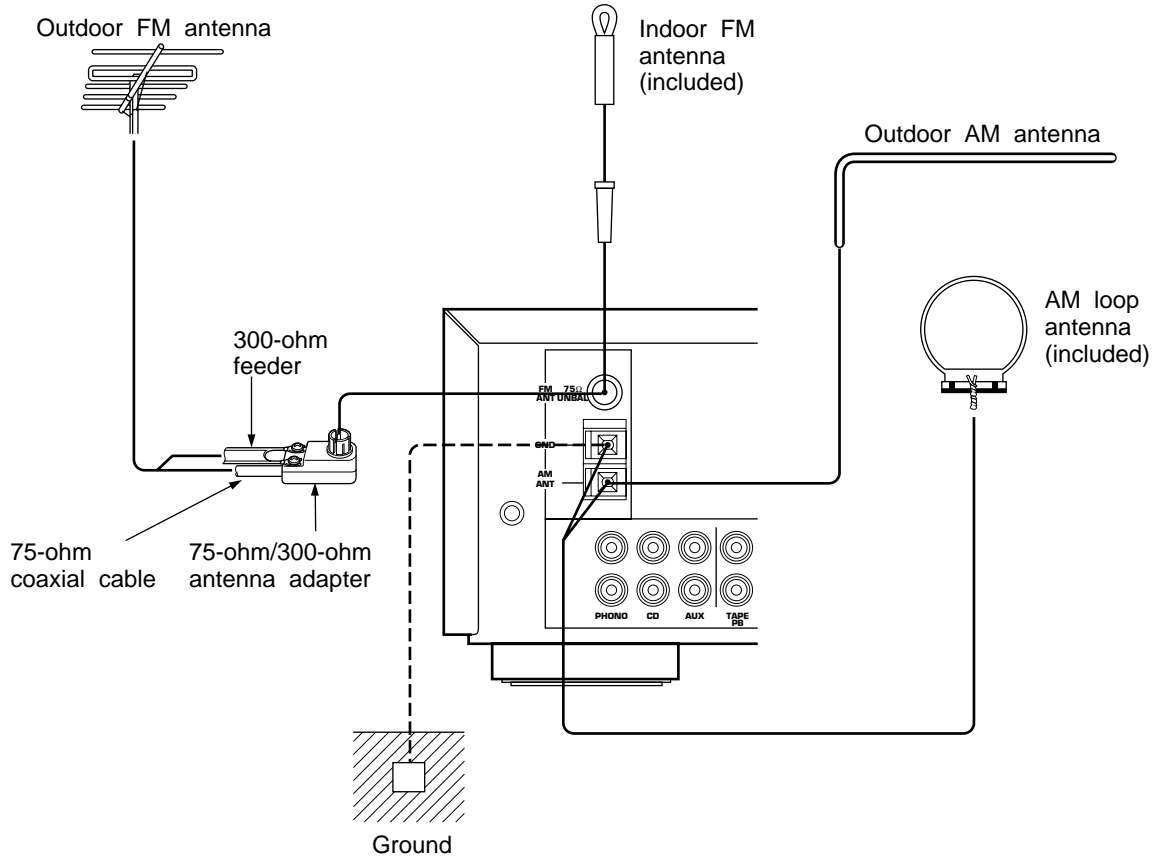

### Connecting the AM loop antenna

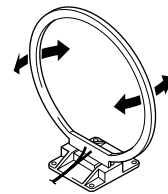
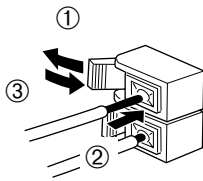

Orient so that the best reception is obtained.

- \* The AM loop antenna should be placed apart from the main unit. The antenna may be hung on a wall.
- \* The AM loop antenna should be kept connected, even if an outdoor AM antenna is connected to this unit.

### GND terminal

For maximum safety and minimum interference, connect the **GND** terminal to a good earth ground. A good earth ground is a metal stake driven into moist earth.

### Notes

- When connecting the indoor FM antenna, make sure that the grooved part of the connector hole is facing downward.
- If you need an outdoor FM antenna to improve FM reception quality, either 300-ohm feeder or coaxial cable may be used. In locations troubled by electrical interference, coaxial cable is preferable.

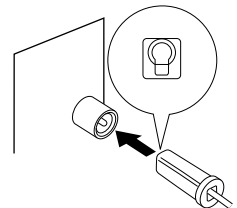

Before attempting to make any connections to or from this unit, be sure to first switch OFF the power to this unit and to any other components to which connections are being made.

## AUDIO CONNECTIONS

When making connections between this unit and other components, be sure all connections are made correctly, that is to say L (left) to L, R (right) to R, “+” to “+” and “-” to “-”. Also, refer to the owner’s manual for each component to be connected to this unit.

### RX-485 RDS

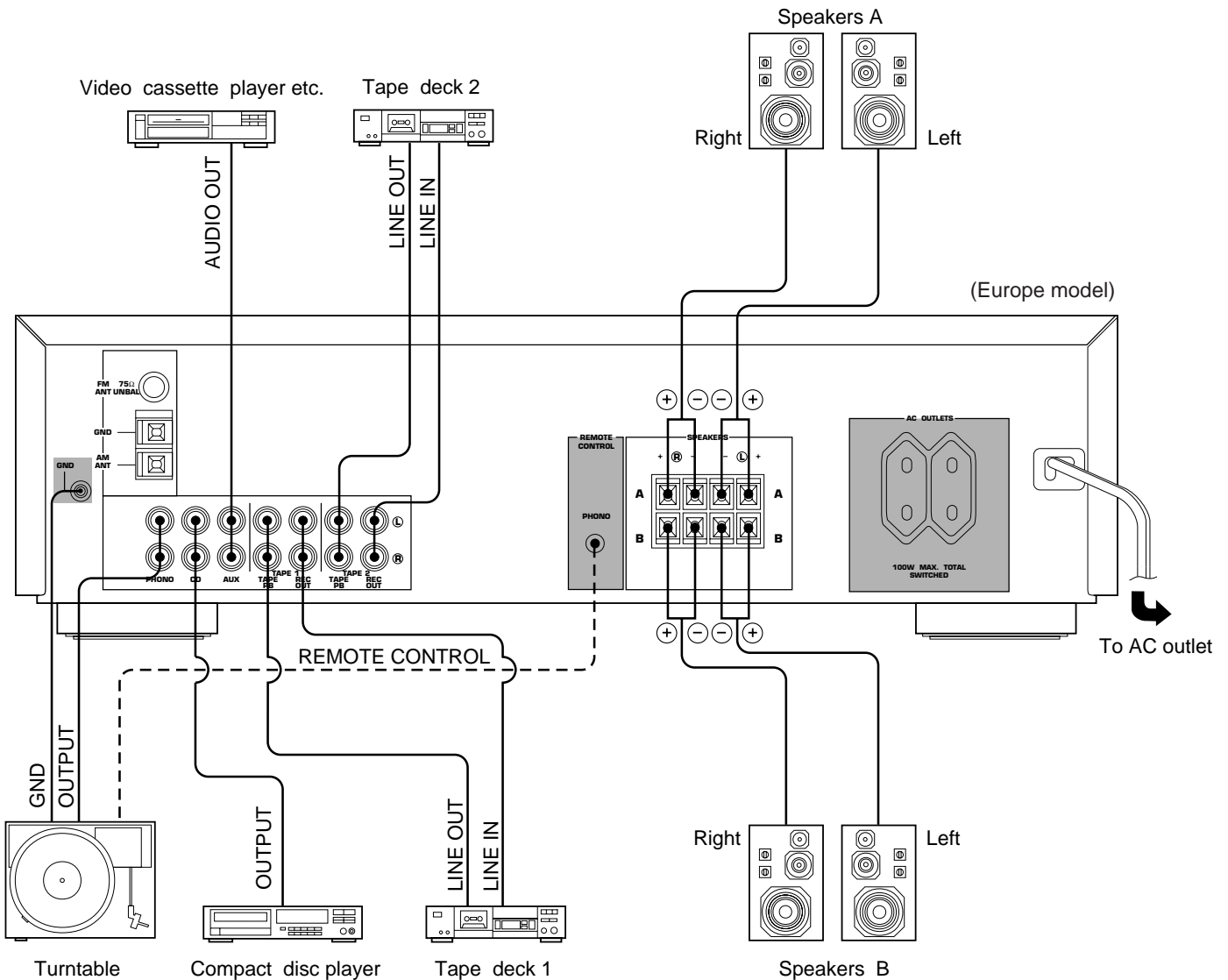

\*  : Refer to “ABOUT THE ACCESSORY TERMINALS” on page 8.

**RX-385, RX-385 RDS**

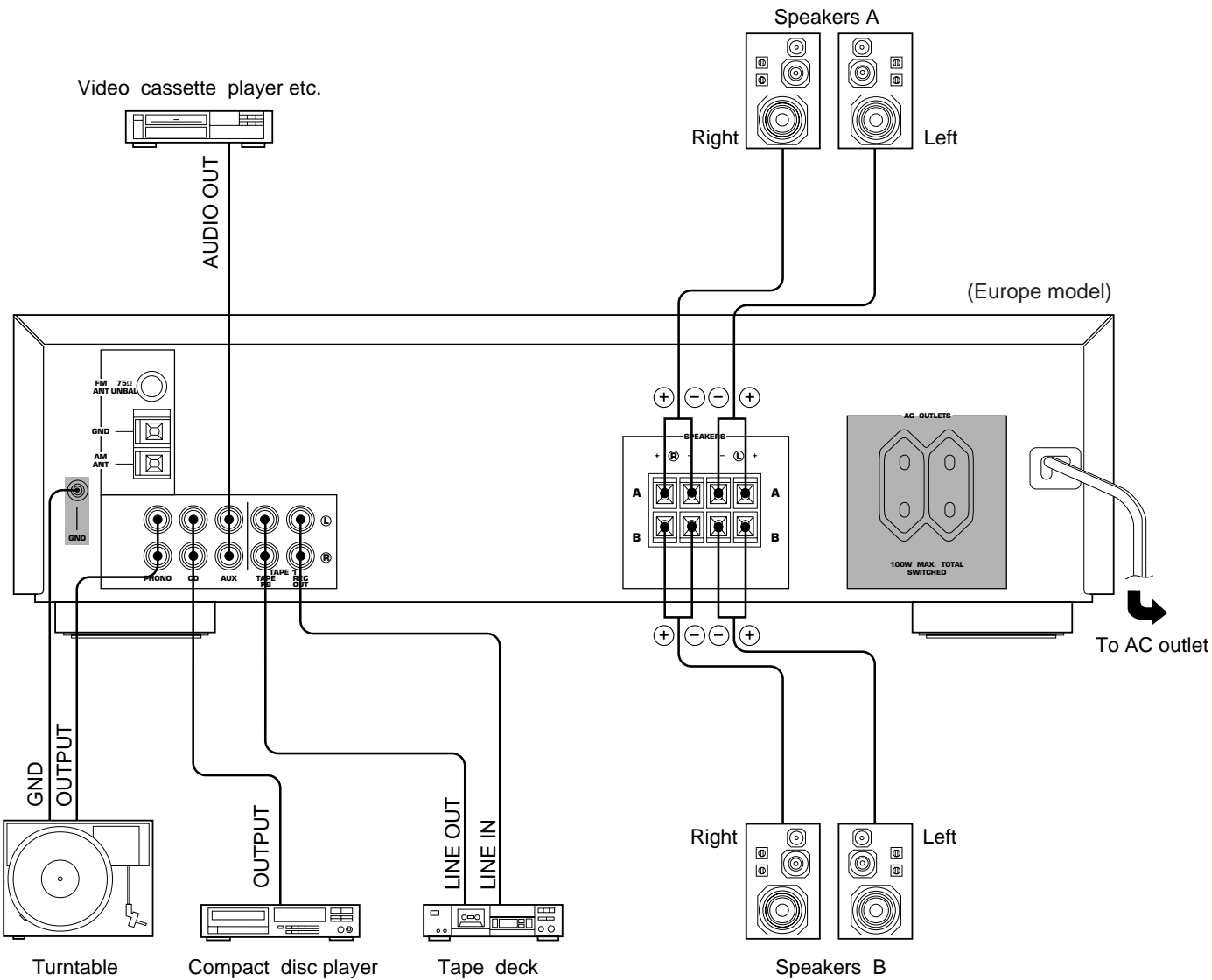

\*  : Refer to "ABOUT THE ACCESSORY TERMINALS" on page 8.

## CONNECTING SPEAKERS

Connect the **SPEAKERS** terminals to your speakers with wire of the proper gauge, cut to be as short as possible. If the connections are faulty, no sound will be heard from the speakers. Make sure that the polarity of the speaker wires is correct, that is, + and – markings are observed. If these wires are reversed, the sound will be unnatural and will lack bass.

**Do not let the bare speaker wires touch each other and do not let them touch the metal parts of this unit as this could damage this unit and/or speakers.**

- One or two speaker systems can be connected to this unit. If you connect only one speaker system, connect it to either the **SPEAKERS A** or **B** terminals.
- Use speakers with the specified impedance shown on the rear of this unit.

### How to Connect:

Red: positive (+)  
Black: negative (–)

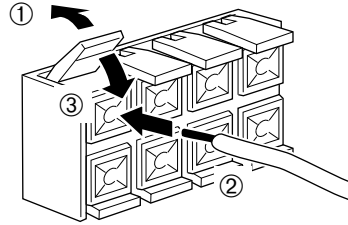

- ① Press up the tab.
- ② Insert the bare wire.  
[Remove approx. 5mm (1/4") insulation from the speaker wires.]
- ③ Press down the tab and secure the wire.

---

## ABOUT THE ACCESSORY TERMINALS

### AC OUTLET(S)

(Europe model) .....2 SWITCHED OUTLETS  
(U.K. model) .....1 SWITCHED OUTLET

Use these to connect the power cords from your components to this unit.

The power to the **SWITCHED** outlets is controlled by this unit's **POWER** switch or the provided remote control transmitter's **POWER** key. These outlets will supply power to any component whenever this unit is turned on.

The maximum power (total power consumption of components) that can be connected to the **SWITCHED AC OUTLET(S)** is 100 watts.

### REMOTE CONTROL (PHONO) connector

#### **RX-485 RDS only**

If you have a YAMAHA turntable with a terminal for remote control, connect it to this connector by using the cable provided with the turntable. This connection allows you to control the turntable from the provided remote control transmitter.

### GND terminal (For turntable use)

Connecting the ground wire of the turntable to this terminal will normally minimize hum, but in some cases better results may be obtained with the ground wire disconnected.



# OPERATIONS

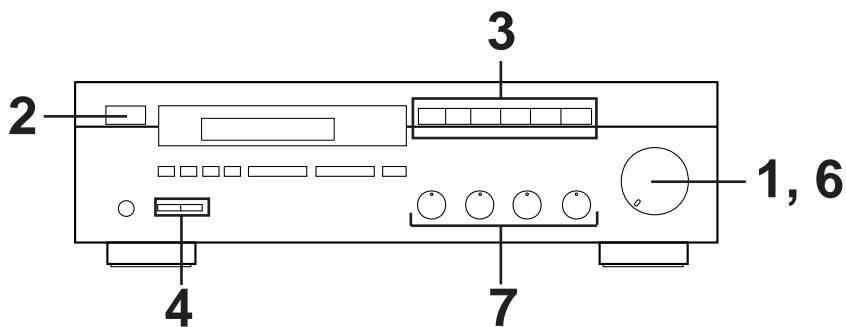

## TO PLAY A SOURCE

**1** **VOLUME**

Set to the "∞" position.

---

**2** **POWER**

---

**3** Select a desired input source.

**RX-485 RDS**

— MONITOR — INPUT

TAPE 2 TAPE 1 AUX TUNER CD PHONO

**RX-385, RX-385 RDS**

TAPE MONITOR INPUT

AUX TUNER CD PHONO

\* The name of the selected input source will appear in the display.

\* Note that pressing on each input selector button selects the source which is connected to the corresponding input terminals on the rear panel.

**4** Select the speakers to be used.

**SPEAKERS**

A B

ON ON

OFF OFF

\* If you use two speaker systems, press both the A and B switches.

---

**5** Play the source. (For detailed information on the tuning operations, refer to the page 12.)

---

**6** **VOLUME**

Adjust to the desired output level.

---

**7** If desired, adjust the **BASS, TREBLE, BALANCE** and **LOUDNESS** controls, etc. (Refer to page 11.)

### Notes

#### **RX-485 RDS only**

- If you select **AUX, TUNER, CD** or **PHONO**, be sure that **TAPE 1** and/or **TAPE 2** are not being selected.
- If you select **TAPE 1** and **TAPE 2** at the same time, the result will be the sound from the tape deck 1.
- For **TAPE 1** and **TAPE 2**, whenever the button is pressed, the corresponding input source is selected or canceled alternately.

#### **RX-385 and RX-385 RDS only**

- If both **TAPE MONITOR** and another input selector button are selected, **TAPE MONITOR** has priority.

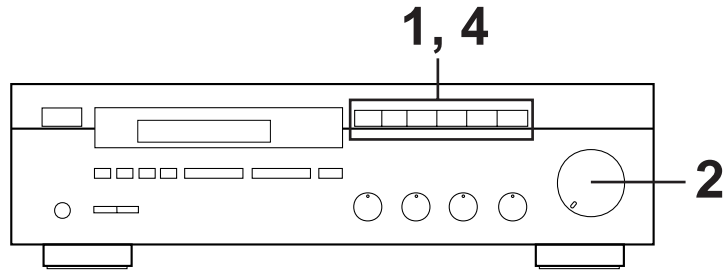

**TO RECORD A SOURCE TO TAPE**  
**RX-485 RDS**

**1** Select the source to be recorded.

\* To dub from tape to tape, refer to the "Notes" shown below.  
 \* When you select **AUX**, **TUNER**, **CD** or **PHONO**, be sure that **TAPE 1** and/or **TAPE 2** are not also selected.

**2** Play the source and then turn the **VOLUME** control up to confirm the input source. (For detailed information on the tuning operations, refer to the page 12.)

**3** Begin recording on the tape deck.

**4** To monitor the audio signals being recorded, press the input selector button for the tape deck being used to make the recording.

**TO RECORD A SOURCE TO TAPE**  
**RX-385, RX-385 RDS**

**1** Select the source to be recorded.

\* When you select **AUX**, **TUNER**, **CD** or **PHONO**, be sure that **TAPE MONITOR** is not also selected.

**2** Play the source and then turn the **VOLUME** control up to confirm the input source. (For detailed information on the tuning operations, refer to the page 12.)

**3** Begin recording on the tape deck.

**4** To monitor the audio signals being recorded, press the **TAPE MONITOR**.

**Note**  
**VOLUME, BASS, TREBLE, BALANCE** and **LOUDNESS** control settings have no effect on the material being recorded.

**Notes**

- **VOLUME, BASS, TREBLE, BALANCE** and **LOUDNESS** control settings have no effect on the material being recorded.
- To dub from tape to tape, only the following method of dubbing can be performed.

SOURCE	RECORDER
Tape deck connected to the TAPE 2 terminals.	→ Tape deck connected to the TAPE 1 terminals.

## Adjusting the BALANCE control

Adjust the balance of the output volume to the left and right speakers to compensate for sound imbalance caused from speaker location or listening room conditions.

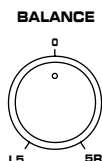

## Selecting the SPEAKER system

Because one or two speaker systems can be connected to this unit, the **SPEAKERS** switches allow you to select speaker system **A** or **B**, or both at once.

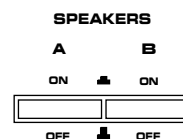

## Adjusting the BASS and TREBLE controls

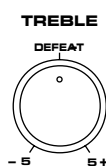
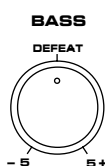

**BASS** : Turn this clockwise to increase (or counter-clockwise to decrease) the low frequency response.

**TREBLE** : Turn this clockwise to increase (or counter-clockwise to decrease) the high frequency response.

## Adjusting the continuously variable LOUDNESS control

This control provides compensation for the human ears' loss of sensitivity to high and low-frequency ranges at low volume. This control is adjustable to retain full tonal range at any volume level.

1

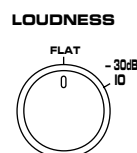

Set to the "FLAT" position.

2

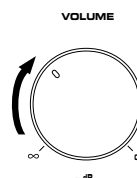

Set to the loudest listening level that you would listen to.

3

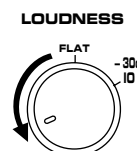

Turn so that the desired volume can be achieved.

## Using the PURE DIRECT switch

### RX-485 RDS only

You can enjoy the purest possible sound from your audio sources by setting this switch ON. By doing so, the audio signal bypasses the **BASS**, **TREBLE**, **BALANCE** and **LOUDNESS** controls, eliminating any alterations to the audio signal.

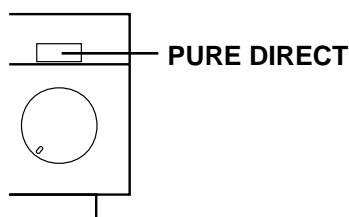

## When you listen with headphones

Connect the headphones to the **PHONES** jack. When listening with headphones privately, set both the **SPEAKERS A** and **B** switches to the **OFF** position.

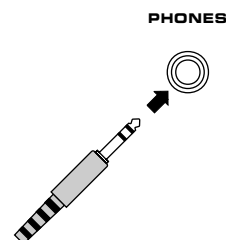

# TUNING OPERATIONS

Normally, if station signals are strong and there is no interference, quick automatic-search tuning (AUTOMATIC TUNING) is possible. However, if signals of the station you want to select are weak, you must tune to it manually (MANUAL TUNING).

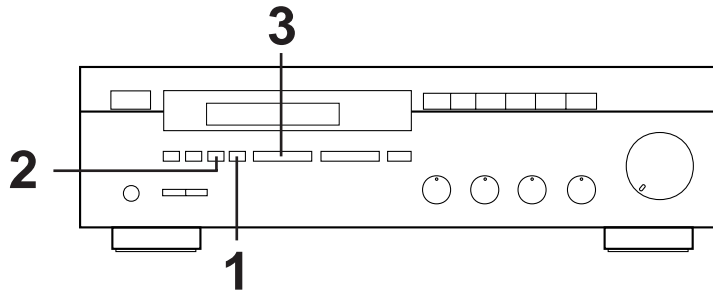

## AUTOMATIC TUNING

- 1** Select the reception band (FM or AM) while watching the display.
- 2**
- 3**

To tune to a higher frequency, press the right side once.  
To tune to a lower frequency, press the left side once.

  - \* If the station where tuning search stopped is not the desired one, press again.
  - \* If the tuning search does not stop at the desired station (because the signals of the station are weak), change to the MANUAL TUNING method.

## MANUAL TUNING

- 1** Select the reception band (FM or AM) while watching the display.
- 2**
- 3** Tune to a desired station manually.
  - \* To continue tuning search, press and hold the button.

### Note

If you tune to an FM station manually, it is received in monaural mode automatically to increase the signal quality.

## Display information

### RX-385

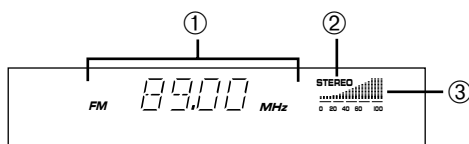

### RX-485 RDS, RX-385 RDS

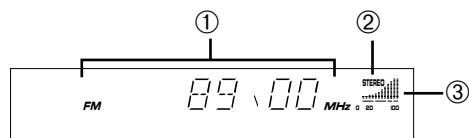

- ① Displays the band and frequency of the received station.

### RX-485 RDS and RX-385 RDS only

If an RDS station is received, the frequency is then replaced by the station name. (However, if the PS data cannot be received within 5 seconds, "NO PS" flashes, and then it returns to the frequency display.) Refer to page 17 for details.



- ② Illuminates when an FM stereo broadcast is received in stereo.
- ③ Indicates the signal level of the received station.

## MANUAL PRESET TUNING

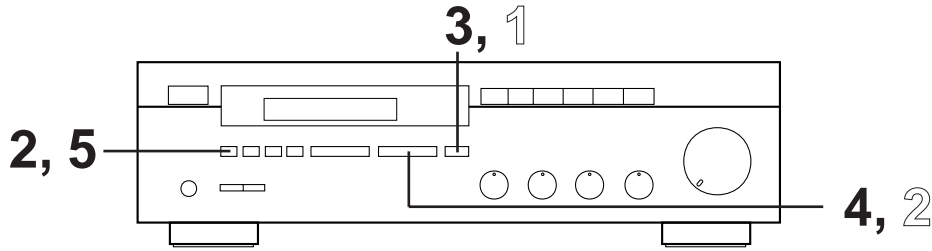
This unit can store station frequencies selected by tuning operation. With this function, you can recall any desired station by only selecting the preset station number where it is stored. Up to 40 stations (8 stations x 5 pages) can be stored.

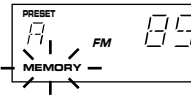
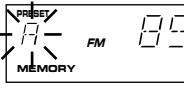
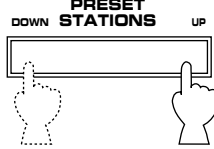

### To store stations

- 1** Tune to a desired station.  
(Refer to the previous page for tuning procedures.)
- 2**  →   
Flashes on and off for about 5 seconds.
- 3** Select a desired page (A – E) of preset stations while watching the display.  
**A/B/C/D/E** → 
- 4** Select a preset station number (1–8) while watching the display before “MEMORY” goes off from the display.  

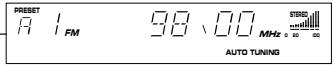
- 5**  →   
Shows the displayed station has been programmed to A1.  
**RX-385**

 →   
Shows the displayed station has been programmed to A1.  
**RX-485 RDS, RX-385 RDS**

\* In the same way, program other stations to A2, A3 ... A8.  
\* You can program more stations on other pages in the same way by selecting other pages in step 3.

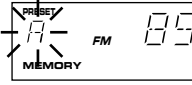
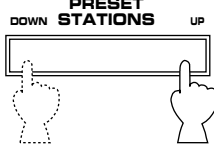
### To recall a preset station

- 1** Select the page where the preset station is stored.  
**A/B/C/D/E** → 
- 2**   
Select the preset station number.

#### Notes

- A new setting can be programmed in place of the former one.
- For presets, the setting of the reception mode (stereo or monaural) is stored along with the station frequency.

#### Memory back-up

The memory back-up circuit prevents the programmed data from being lost even if the **POWER** switch is set off or the power plug is disconnected from the AC outlet or the power is cut due to temporary power failure. If, however, the power is cut for more than one week, the memory may be erased. If so, it can be re-programmed by simply following the PRESET TUNING steps.

# AUTOMATIC PRESET TUNING

You can also make use of an automatic preset tuning function for FM stations only. By this function, this unit performs automatic tuning and stores FM stations with strong signals sequentially. Up to 40 stations are stored automatically in the same way as in the manual preset tuning method on page 13.

**RX-485 RDS and RX-385 RDS only**

\* Only RDS stations can be stored by this function.

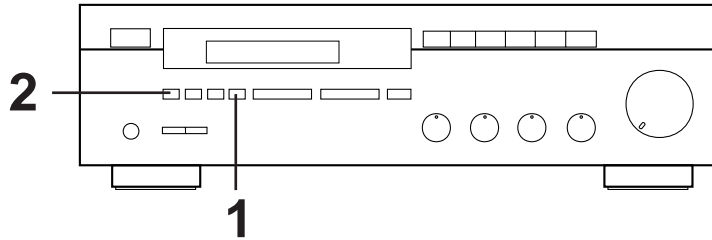

## To store stations

**1**

**2**

Press and hold for about 3 seconds.

Flashes.      and      Flashes.

After 5 seconds, the automatic preset tuning begins from A1. Received stations are programmed to A1, A2 ... A8 sequentially.

\* If more than 8 stations are received, they are also programmed to the preset station numbers on other pages (B, C, D and E) in that order.

### If you want to store the first station received by the automatic preset tuning to a desired preset station number.

If, for example, you want to store the received first station to C5, select "C5" by using the **A/B/C/D/E** button and the **PRESET STATIONS** button soon after the display begins flashing on/off in step 2. After a few seconds, the automatic preset tuning begins. The received first station is stored to C5, and next stations to C6, C7 ... sequentially. If stations are stored up to E8, the automatic preset tuning is finished automatically.

### When the automatic preset tuning is finished

The display shows the frequency of the last preset station. Check the contents and the number of preset stations by following the procedure of the section "To recall a preset station" on page 13.

### To recall a preset station

Simply follow the procedure of the section "To recall a preset station" on page 13.

**RX-485 RDS and RX-385 RDS only**

\* A recalled station is shown by the frequency or station name on the display.

### Notes

- You can replace a preset station by another FM or AM station manually by simply following the procedure of the section "To store stations" on page 13.

**RX-385 only**

- If the number of received stations is not enough to be stored up to E8, the search is finished automatically when it reaches the highest frequency after searching through all frequencies.
- With this function, only FM stations with sufficient signal strength are stored automatically. If the station you want to program is weak in signal strength, tune to it in monaural manually and program it by following the procedure of the section "To store stations" on page 13.

**RX-485 RDS and RX-385 RDS only**

- The automatic preset tuning search will be performed through all RDS network frequencies until stations are stored up to E8. If the number of received stations is not enough to be stored up to E8, the search is finished automatically after searching through all frequencies.
  - With this function, only RDS stations with sufficient signal strength are stored automatically. If the station you want to program is weak in signal strength, tune to it in monaural manually and program it by following the procedure of the section "To store stations" on page 13.
- \* There may be a case that this function cannot receive a station which could be received by the automatic tuning method. This is because this function receives a large volume of PI (Program Identification) data along with the station.

## EXCHANGING PRESET STATIONS

You can exchange the places of two preset stations each other by easy operations.

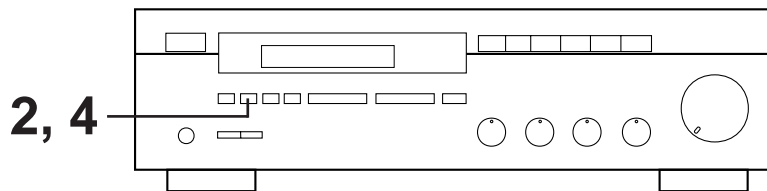

### Example)

If you want to shift the preset station on E1 to A5, and vice versa.

<b>1</b>	Recall the preset station on E1 (by following the method of "To recall a preset station" on page 13).
<b>2</b>	
<b>3</b>	Next, recall the preset station on A5 by following the same method with step 1. 

<b>4</b>	
	Shows the exchange of stations is completed.

# RECEIVING RDS STATIONS

## **RX-485 RDS and RX-385 RDS only**

RDS (Radio Data System) is a data transmission system gradually being introduced by FM stations in many countries. Stations using this system transmit an inaudible stream of data in addition to the normal radio signal.

RDS data contains various information, such as AF (Alternative Frequencies for the same program station), PI (Program Identification), PS (Program Service station name), PTY (Program Type name), etc.

RDS function is carried out among the network stations.

\* This unit utilizes AF, PI, PS and PTY to receive RDS broadcast stations.

### Displaying RDS data

This unit can be turned into the following two modes to display RDS data.

#### **PS (Program Service station name) mode:**

Displays the name of the RDS station now being received instead of the frequency.

**BBC R3**

#### **PTY (Program Type name) mode:**

Displays the program type of the RDS station now being received. There are 15 program types to classify RDS stations as follows.

<b>NEWS</b>	<b>News:</b> Short accounts of facts, events and publicly expressed views, reportage and actuality.	<b>VARIED</b>	<b>Varied:</b> Used for mainly speech-based programs usually of light-entertainment nature, not covered by above categories. Examples are: quizzes, panel games, personality interviews, comedy and satire.
<b>AFFAIRS</b>	<b>Current affairs:</b> Topical program expanding or enlarging upon the news, generally in different presentation style or concept, including documentary debate, or analysis	<b>POP M</b>	<b>Pop:</b> Commercial music, which would generally be considered to be of current popular appeal, often featuring in current or recent record sales charts.
<b>INFO</b>	<b>Information:</b> Program whose purpose is to impart advice in the widest sense, including meteorological reports and forecasts, consumer affairs, medical help, etc.	<b>ROCK M</b>	<b>Rock:</b> Contemporary modern music, usually written and performed by young musicians.
<b>SPORT</b>	<b>Sport:</b> Program concerned with any aspect of sport.	<b>MOR M</b>	<b>M.O.R.:</b> (Middle of the Road Music). Common term to describe music considered to be "easy-listening", as opposed to Pop, Rock or Classical. Music in this category is often but not always, vocal, and usually of short duration (<5 min.)
<b>EDUCATE</b>	<b>Education:</b> Program intended primarily to educate, of which the formal element is fundamental.	<b>LIGHT M</b>	<b>Light classics:</b> Classical Musical for general, rather than specialist appreciation. Examples of music in this category are instrumental music, and vocal or choral works.
<b>DRAMA</b>	<b>Drama:</b> All radio plays and serials.	<b>CLASSICS</b>	<b>Serious classics:</b> Performances of major orchestral works, symphonies, chamber music etc., and including Grand Opera.
<b>CULTURE</b>	<b>Culture:</b> Programs concerned with any aspect of national or regional culture, including religious affairs, philosophy, social science, language, theatre, etc.	<b>OTHER M</b>	<b>Other music:</b> Musical styles not fitting into any of the above categories. Particularly used for specialist music, of which Jazz, Rhythm & Blues, Folk, Country, and Reggae are examples.
<b>SCIENCE</b>	<b>Science:</b> Programs about the natural sciences and technology.		



## To turn the unit into the PS mode or PTY mode

Press the **FREQ/PS/PTY** button. Whenever pressed, the mode changes into the PS mode, PTY mode and returns to usual mode in turn.

\* When an RDS station is received, the display is automatically turned into the PS mode. Do not press the **FREQ/PS/PTY** button until the display is turned into the PS mode. If the button is pressed before the display mode is changed, it may occur that "NO PS" flashes on the display. This is because the unit has not received all of the RDS data on the station yet.

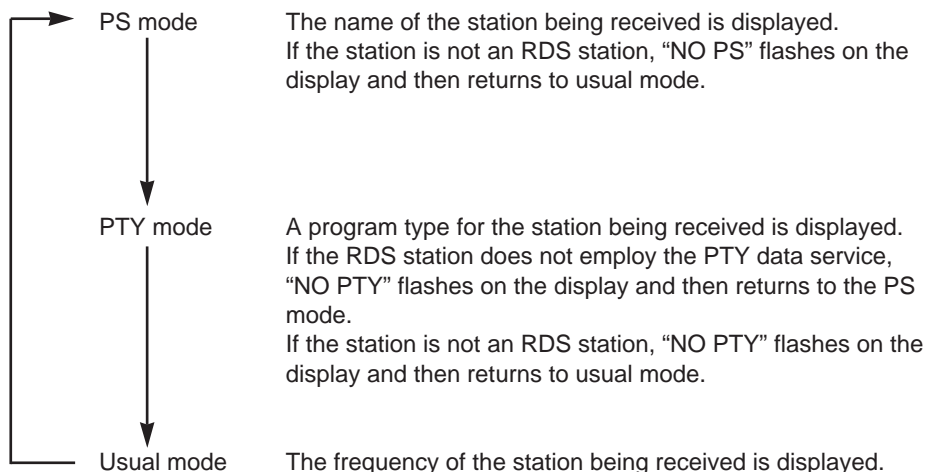
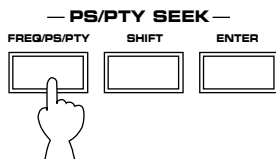

### Note

When PS or PTY data reception is not possible due to poor reception conditions, "NO PS" or "NO PTY" flashes on the display in each mode. In such a case, press the **TUNING MODE** button so that "AUTO TUNING" goes off from the display. Though the reception mode is changed to monaural by this operation, when you changes to the PS or PTY mode, PS or PTY data may be displayed.

## Calling a preset RDS station by the station name (PS SEEK)

You can call a desired RDS station stored in this unit by only inputting the name of the station in the PS mode. By this operation, this unit searches all preset stations for the station. You do not have to input a full name, even only the first letter can be used for calling. As many as 8 letters and/or numerals can be selected for inputting a name.

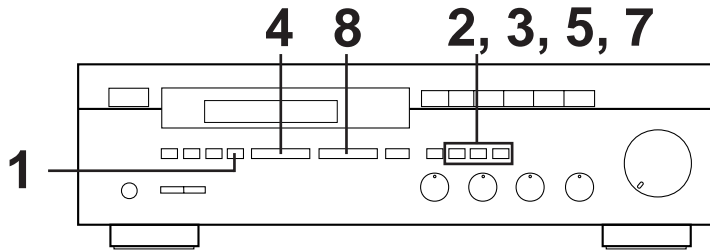

**1** →

**2** Turn the unit into the PS mode.  
 — PS/PTY SEEK —  
 → A station name is displayed or "NO PS" flashes.  
 \* If "NO PS" flashes, proceed to the next step while flashing. If "NO PS" disappears before you proceed to the next step, press the **FREQ/PS/PTY** button again.

**3** — PS/PTY SEEK —  
 →   
 Flashes.

**4** Select the first letter or numeral of the station name.  
 →   
 \* By pressing the **TUNING** button repeatedly or by pressing and holding it, the display will change letters and numerals in sequence.  
 \* If you will not input the second letter, skip to step 7.

**5** When the first letter or numeral of the station name appears, press the **SHIFT** button to proceed to the selection of the next letter or numeral.  
 — PS/PTY SEEK —  
 →   
 "A" will flash on the second letter or numeral position.

**6** Repeat steps 4 and 5 for other letters and/or numerals, if necessary.

**7** When inputting the name is finished, press the **ENTER** button.  
 — PS/PTY SEEK —  
 →   
 Flashes.

**8** Press once.  
 The unit begins searching for the station, and it is continued until the station is found.

**You do not have to input a full name for searching for the station**  
 You may input only the first letter of the station name. If doing so, you can skip steps 5 and 6. In step 8, the unit searches for and calls a nearest station which has the letter you input. If the station is not the desired one, press the **PRESET STATIONS** button again. The unit will begin searching for another station which has the same letter.

**To cancel this function**  
 Press the **AF, FREQ/PS/PTY, SHIFT, ENTER, FM/AM** or **MEMORY** button.

- Notes**
- If no station is found by this function after searching all preset stations, "NO PS" flashes for about 3 seconds on the display, and then it returns to the mode which had been obtained before the searching was performed.
  - This function is useful especially for calling a station with weak signals which cannot be received by the automatic tuning method. By only storing such a station, you can call it any time easily.

## Calling a preset RDS station by the program type (PTY SEEK)

By designating a program type, the unit automatically searches all preset stations for RDS stations of that program type.

\* There are 15 program types to classify RDS stations. For details, refer to page 16.

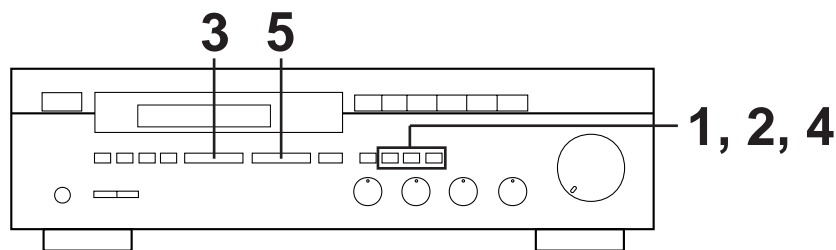

### 1 Turn the unit into the PTY mode.

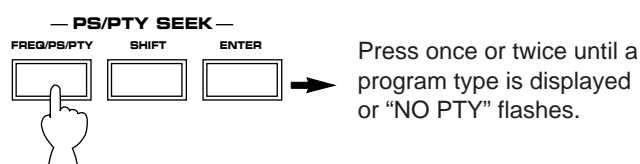

\* If "NO PTY" flashes, proceed to the next step while flashing. If "NO PTY" disappears before you proceed to the next step, press the **FREQ/PS/PTY** button once or twice.

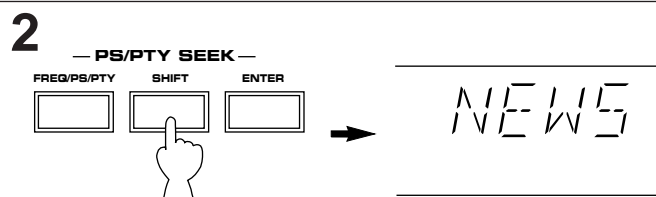

### 3 Select the desired program type.

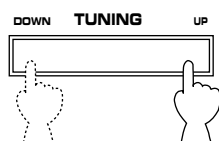

\* By pressing the **TUNING** button repeatedly or by pressing and holding it, the display will change program types in sequence.

### 4 When the desired program type appears, press the ENTER button.

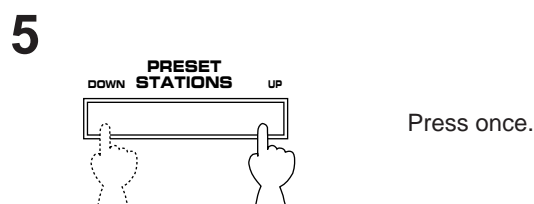
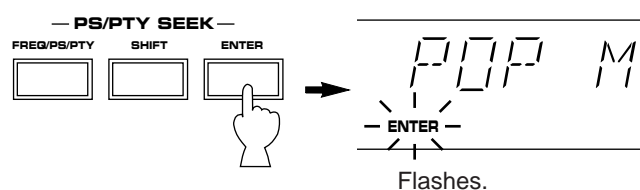

The unit begins searching all preset stations, and calls a station of the program type if such a station is found.

\* When the right side of the **PRESET STATIONS** button is pressed, the search is performed from "A1" toward higher numbers of the preset stations (A1, A2 ... A8, B1, B2, ...). If, however, "A3" is currently being called for example, the search begins from the next station "A4".

When the left side of the **PRESET STATIONS** button is pressed, the search is performed in reverse order.

If the called station is not the desired one, press the **PRESET STATIONS** button again to search for another station of the same program type.

### To cancel this function

Press the **AF**, **FREQ/PS/PTY**, **SHIFT**, **ENTER**, **FM/AM** or **MEMORY** button.

### Note

If no station is found by this function, after searching all preset stations, "NO PTY" flashes for about 3 seconds on the display, and then it returns to the mode which had been obtained before the searching was performed.

## Calling the best quality RDS station which broadcasts the same program (AF SEEK)

This function automatically searches for and calls another RDS station of the best reception quality which broadcasts the same program now you are listening to. This function utilizes AF (Alternative Frequencies for the same program station) and PI (Program Identification) of RDS data service. The search is carried out among the RDS network stations.

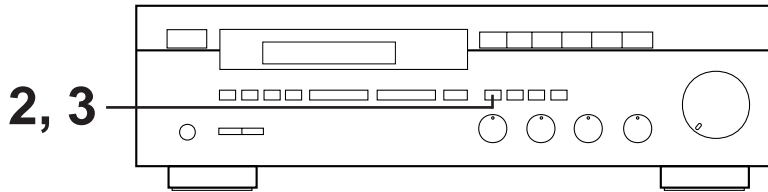

**1** Tune to a desired RDS station.  
 \* Wait for about 10 seconds before proceeding to the next step. This is for making this unit carry out searching more stations.

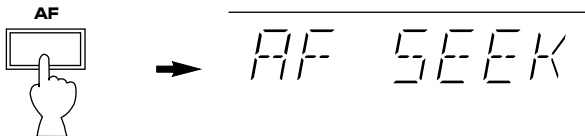
**2** 

The unit searches network stations for other stations with the same program.  
 \* If the station is not an RDS station, or there is no other station with the same program, "NO AF" flashes.



Stations with the same program are all stored and numbered from the best quality station in sequence.

AF SEEK 1  
 ↓  
 AF SEEK 2  
 ⋮  
 AF SEEK 5

When the search is finished, the best quality station is called.

**3** If desired, you can call the second station by pressing the **AF** button.

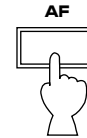

Whenever the **AF** button is pressed, stored stations are called in sequence. When pressed after the last station is selected, the first one is restored.

### To cancel this function

Press a button other than the **AF** button.  
 All of the stored stations will be also cleared.

# REMOTE CONTROL TRANSMITTER

The remote control transmitter provided with this unit is designed to control all the most commonly used functions of the unit. If the CD player, turntable and tape deck connected to this unit are YAMAHA components, then this remote control transmitter will also control various functions of each component.

## KEY FUNCTIONS

### For Control of This Unit

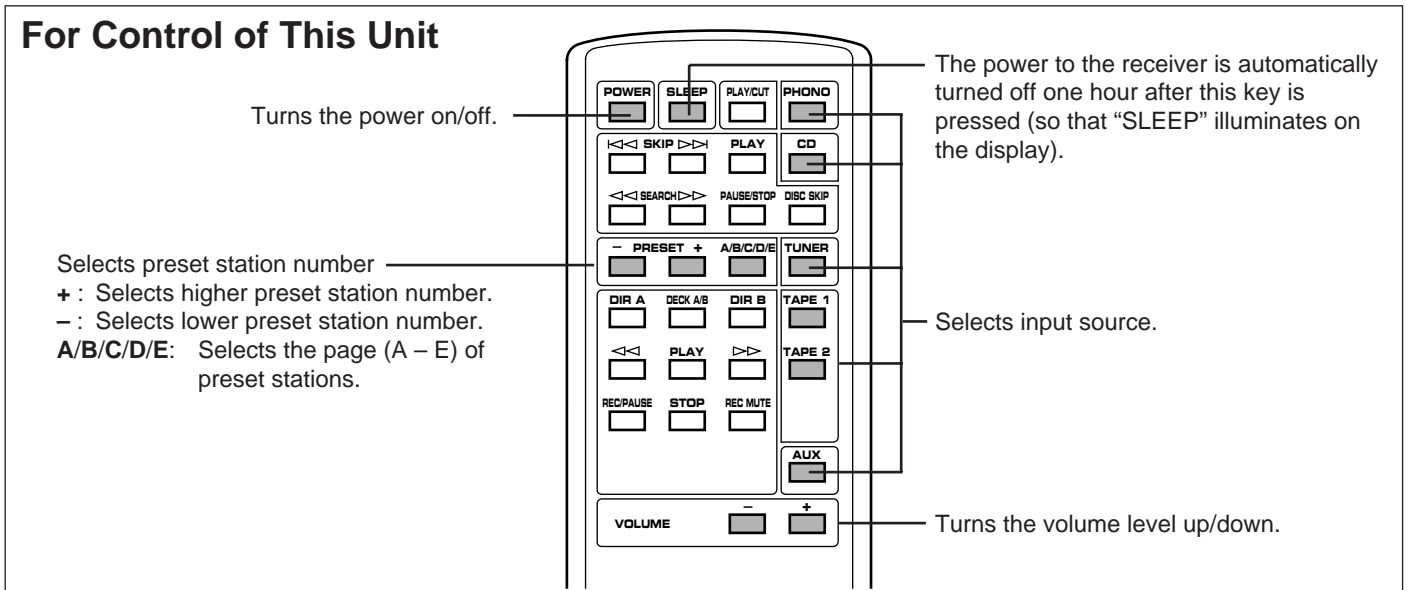

### For Other Component Control

Identify the remote control transmitter keys with your component's keys. If these keys are identical, their function will be the same. On each key function, refer to the corresponding instruction on your component's manual.

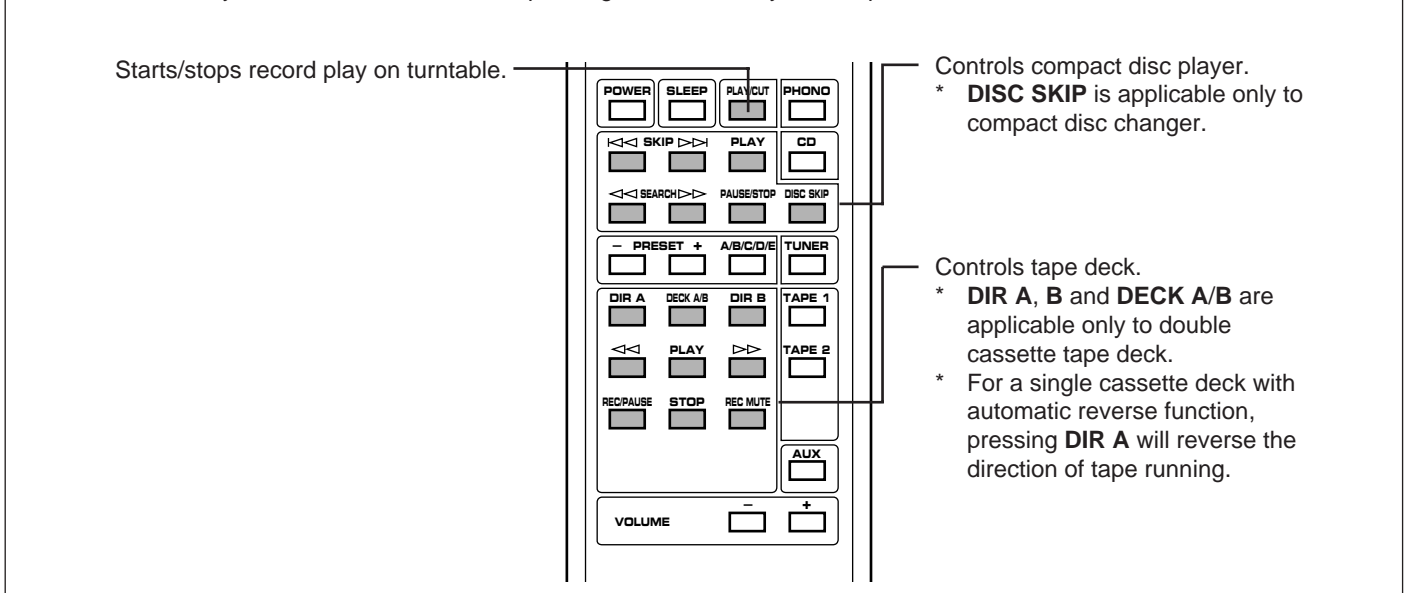

**Illustrations :** **RX-485 RDS**

\* **PLAY/CUT** is equipped only on RX-485 RDS.

\* **TAPE 1** and **TAPE 2** are equipped only on RX-485 RDS. On RX-385 and RX-385 RDS, they are replaced by **TAPE** only.

### STANDBY mode (Europe model only)

While the power is on, pressing the **POWER** key on the remote control transmitter switches the unit to the **STANDBY** mode. (In this mode, the standby indicator on the front panel is half illuminated.)

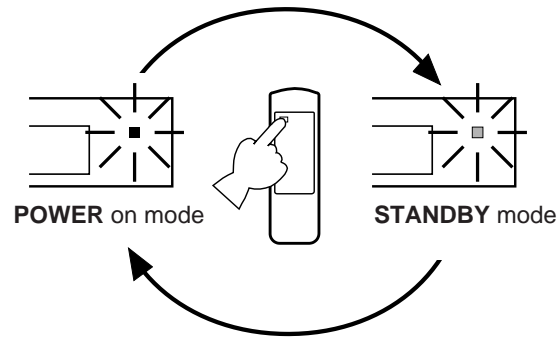

## NOTES ABOUT THE REMOTE CONTROL TRANSMITTER

### Battery installation

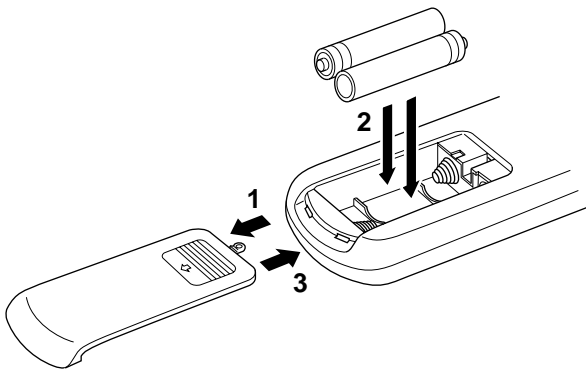

### Battery replacement

If you find that the remote control transmitter must be used closer to the main unit, the batteries are weak. Replace both batteries with new ones.

#### Notes

- Use only AA, R6, UM-3 batteries for replacement.
- Be sure the polarities are correct. (See the illustration inside the battery compartment.)
- Remove the batteries if the remote control transmitter will not be used for an extended period of time.
- If batteries leak, dispose of them immediately. Avoid touching the leaked material or letting it come in contact with clothing, etc. Clean the battery compartment thoroughly before installing new batteries.

### Remote control transmitter operation range

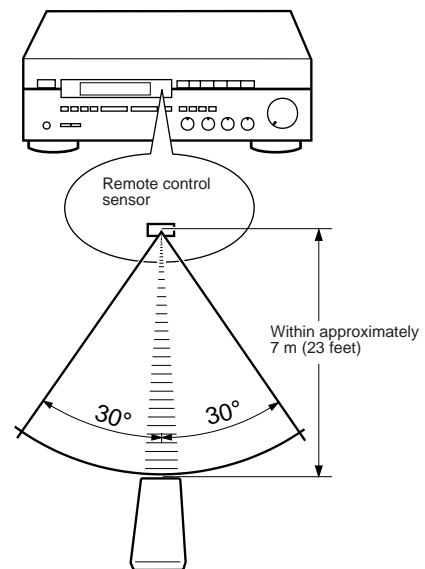

#### Notes

- There should be no large obstacles between the remote control transmitter and the main unit.
- If the remote control sensor is directly illuminated by strong lighting (especially an inverter type of fluorescent lamp etc.), it might cause the remote control transmitter not to work correctly. In this case, reposition the main unit to avoid direct lighting.

# TROUBLESHOOTING

If the unit fails to operate normally, check the following points to determine whether the fault can be corrected by the simple measures suggested. If it cannot be corrected, or if the fault is not listed in the SYMPTOM column, disconnect the power cord and contact your authorized YAMAHA dealer or service center for help.

	SYMPTOM	CAUSE	REMEDY
Amplifier	The unit fails to turn on when the POWER switch is pressed.	Power cord is not plugged in or is not completely inserted.	Firmly plug in the power cord.
	No sound.	Incorrect output cord connections.	Connect the cords properly. If the problem persists, the cords may be defective.
		Appropriate input selector button is not pressed.	Press the appropriate input selector button corresponding to the input source.
	The sound suddenly goes off.	The protection circuit has activated because of short circuit etc.	Turning the unit off and then on will reset the protection circuit.
	Only one side speaker outputs the sound.	Incorrect setting of the BALANCE control	Adjust it to the appropriate position.
		Incorrect cord connection.	Connect the cord properly. If the problem persists, the cables may be defective.
	Sound "hums".	Incorrect cord connections.	Firmly connect the audio plugs. If the problem persists, the cord may be defective.
		No connection from the turntable to the GND terminal.	Make the GND connection between the turntable and this unit.
	The volume level is low while playing a record.	The record is being played on a turntable with an MC cartridge.	The player should be connected to the receiver through the MC head amplifier.
	The volume level cannot be increased, or sound is distorted.	The power to the component connected to the REC OUT terminals of this unit is off.	Turn the power to the component on.
FM	FM stereo reception is noisy.	Because of the characteristics of FM stereo broadcasts, this is limited to cases where the transmitter is too far or the antenna input is poor.	Check the antenna connections. Try using a multiple element FM antenna.
	There is distortion and clear reception cannot be obtained even with a good FM antenna.	There is multipath interference.	Adjust antenna placement to eliminate multipath interference.
	A desired station cannot be tuned in with Auto tuning.	The station is too weak.	Use Manual tuning mode. Use high quality directional FM antenna.
AM	A desired station cannot be tuned in with Auto tuning.	Weak signal or loose antenna connections.	Use Manual tuning mode.
			Tighten the AM loop antenna connections and rotate it for best reception.
	There are continuous crackling and hissing noises.	Noises will result from lightning, fluorescent lamps, motors, thermostats and other electrical equipment.	Use an outdoor antenna and a ground wire. This will help somewhat but it is difficult to eliminate all noises.
Remote control transmitter	There are buzzing and whining noises (especially in the evening).	A television set is being used nearby.	Relocate this unit away from the TV.
	The remote control transmitter does not work.	Direct sunlight or lighting (of an inverter type of fluorescent lamp etc.) is striking the remote control sensor of the main unit.	Change position of the main unit.
Others	The sound is degraded when monitoring is performed by using the headphones connected to the compact disc player or cassette deck which are connected with this unit.	The batteries of this remote control transmitter are too weak.	Replace the batteries with new ones.
		The power to this unit is off.	Turn the power to this unit on.

# SPECIFICATIONS

## AUDIO SECTION

Minimum RMS Output Power per Channel	
8 ohms, 20 Hz to 20 kHz, 0.04% THD	
<RX-485 RDS> .....	65W+65W
<RX-385/385 RDS>	
[U.S.A. and Canada models].....	45W+45W
[Australia, U.K., Europe and	
General models].....	40W+40W
6 ohms, 20 Hz to 20 kHz, 0.06% THD	
<RX-485 RDS> .....	70W+70W
<RX-385/385 RDS>	
[U.S.A. and Canada models].....	48W+48W
Dynamic Power per Channel	
(by IHF Dynamic Headroom measuring	
method)	
<RX-485 RDS>	
8/6/4/2 ohms .....	95/115/135/150W
<RX-385/385 RDS>	
[U.S.A., Canada and General models]	
8/6/4/2 ohms .....	69/78/90/98W
[Australia, Europe and U.K. models]	
8/6/4/2 ohms .....	68/75/85/95W
DIN Standard Output Power per Channel	
4 ohms, 1 kHz, 0.7% THD	
[Europe model only]	
<RX-485 RDS> .....	85W
<RX-385/385 RDS> .....	55W
IEC Power	
<RX-485 RDS>	
8 ohms, 1 kHz, 0.04% THD	
[Europe model only].....	75W
<RX-385/385 RDS>	
8 ohms, 1 kHz, 0.04% THD	
[Europe model only].....	50W
Damping Factor	
8 ohms, 20 Hz to 20 kHz .....	80
Input Sensitivity/Impedance	
PHONO MM .....	2.5 mV/47 k-ohms
CD/TAPE/AUX .....	150 mV/47 k-ohms
Maximum Input Signal (1 kHz, 0.01% THD)	
PHONO MM .....	80 mV
Headphone Jack Rated Output/Impedance	
8 ohms, 20 Hz to 20 kHz, 0.04% THD	
Output Level	
<RX-485 RDS> .....	0.46V
<RX-385/385 RDS> .....	0.45V
Impedance	
<RX-485 RDS> .....	390 ohms
<RX-385/385 RDS> .....	330 ohms
Frequency Response (20 Hz to 20 kHz)	
CD/TAPE/AUX.....	0±0.5 dB
RIAA Equalization Deviation	
PHONO MM .....	0±0.5 dB
Total Harmonic Distortion (20 Hz to 20 kHz)	
PHONO MM to REC OUT (1V) .....	0.02%
CD/TAPE/AUX to SP OUT	
<RX-485 RDS>	
(32.5W/8 ohms).....	0.02%
<RX-385/385 RDS>	
(22.5W/8 ohms).....	0.02%
Signal-to-Noise Ratio (IHF-A Network)	
PHONO MM (5 mV Input Shorted).....	82 dB
CD/TAPE/AUX (Input Shorted) .....	105 dB
Residual Noise (IHF-A Network).....	100 µV
Channel Separation (Vol. -30 dB)	
PHONO MM (Input Shorted 1 kHz).....	60 dB
CD/TAPE/AUX	
(Input 5.1 k-ohms Terminated 1 kHz)....	60 dB
Tone Control Characteristics	
BASS: Boost/cut .....	±10 dB (50 Hz)
(Turnover frequency)	
.....	(350 Hz)
TREBLE: Boost/cut.....	±10 dB (20 kHz)
(Turnover frequency)	
.....	(3.5 kHz)
Continuous Loudness Control	
.....	- 30 dB (1 kHz)
(Level related equalization)	

## FM SECTION

Tuning Range	
[U.S.A., Canada and General models]	
.....	87.5 to 107.9 MHz
[Australia, Europe, U.K. and General	
models] .....	87.5 to 108.0 MHz
50 dB Quieting Sensitivity (IHF, 75 ohms)	
<RX-485 RDS/385>	
[Except Europe model]	
Mono .....	1.55 µV (15.1 dBf)
Stereo .....	21 µV (37.7 dBf)
<RX-385 RDS>	
Mono .....	1.55 µV (15.1 dBf)
Stereo .....	21 µV (37.7 dBf)
Usable Sensitivity (75 ohms)	
(30 dB S/N Quieting, 1 kHz, 100% mod.)	
<RX-485 RDS/385>	
[Except Europe model]	
.....	0.8 µV (9.3 dBf)
DIN, Mono (S/N 26 dB) [Europe model]	
.....	0.9 µV
DIN, Stereo (S/N 46 dB) [Europe model]	
.....	24 µV
<RX-385 RDS>	
[Except Europe and U.K. models]	
.....	0.8 µV (9.3 dBf)
DIN, Mono (S/N 26 dB)	
[Europe and U.K. models] .....	0.9 µV
DIN, Stereo (S/N 46 dB)	
[Europe and U.K. models] .....	24 µV
Image Response Ratio	
<RX-485 RDS/385>	
[Except Europe and U.K. models].....	45 dB
[Europe model] .....	80 dB
<RX-385 RDS>	
[Except Europe and U.K. models].....	45 dB
[Europe and U.K. models].....	80 dB
IF Response Ratio .....	80 dB
Spurious Response Ratio .....	70 dB
AM Suppression Ratio .....	55 dB
Capture Ratio.....	1.5 dB
Alternate Channel Selectivity	
<RX-485 RDS/385>	
[Except Europe model] .....	85 dB
<RX-385 RDS>	
[Except Europe and U.K. models].....	85 dB
Selectivity (two signals, 40 kHz Dev.)	
<RX-485 RDS/385>	
[Europe model] .....	70 dB
<RX-385 RDS>	
[Europe and U.K. models].....	70 dB
Signal-to-Noise Ratio	
<RX-485 RDS/385>	
(IHF) Mono/Stereo	
[Except Europe model].....	80 dB/75 dB
(DIN-Weighted, 40 kHz Dev.) Mono/Stereo	
[Europe model] .....	74 dB/69 dB
<RX-385 RDS>	
(IHF) Mono/Stereo	
[Except Europe and U.K. models]	
.....	80 dB/75 dB
(DIN-Weighted, 40 kHz Dev.) Mono/Stereo	
[Europe and U.K. models] .....	74 dB/69 dB
Harmonic Distortion	
<RX-485 RDS/385>	
Mono/Stereo (1 kHz)	
[Except Europe model].....	0.1/0.2%
Mono/Stereo (40 kHz Dev.)	
[Europe model] .....	0.1/0.2%
<RX-385 RDS>	
Mono/Stereo (1 kHz)	
[Except Europe and U.K. models]	
.....	0.1/0.2%
Mono/Stereo (40 kHz Dev.)	
[Europe and U.K. models] .....	0.1/0.2%
Stereo Separation	
<RX-485 RDS/385> (1 kHz).....	50 dB

<RX-385 RDS>	
[Except Europe and U.K. models]	
(1 kHz).....	50 dB
[Europe and U.K. models]	
(40 kHz Dev.) .....	50 dB
Frequency Response	
20 Hz to 15 kHz.....	0 ±1.5 dB

## AM SECTION

Tuning Range	
[U.S.A., Canada and General models]	
.....	530 to 1,710 kHz
[Australia, U.K., Europe and General	
models] .....	531 to 1,611 kHz
Usable Sensitivity .....	100 µV/m
Selectivity.....	32 dB
Signal-to-Noise Ratio .....	50 dB
Image Response Ratio .....	40 dB
Spurious Response Ratio .....	50 dB
Harmonic Distortion.....	0.3%

## AUDIO SECTION

Output Level/Impedance	
<RX-485 RDS/385>	
FM (100% mod., 1 kHz)	
[Except Europe model]	
.....	500 mV/2.2 k-ohms
[Europe model (40 kHz Dev.)]	
.....	400 mV/2.2 k-ohms
AM (30% mod., 400 Hz)	
.....	150 mV/2.2 k-ohms
<RX-385 RDS>	
FM (100% mod., 1 kHz)	
[Except Europe and U.K. models]	
.....	500 mV/2.2 k-ohms
[Europe and U.K. models (40 kHz Dev.)]	
.....	400 mV/2.2 k-ohms
AM (30% mod., 400 Hz)	
.....	150 mV/2.2 k-ohms

## GENERAL

Power Supply	
[U.S.A. and Canada models]	
.....	AC 120V, 60 Hz
[Australia and U.K. models]	
.....	AC 240V, 50 Hz
[Europe model] .....	AC 230V, 50 Hz
[General model]	
.....	AC 110/120/220/240V, 50/60 Hz
Power Consumption	
<RX-485 RDS>	
[U.S.A. model].....	155W
[Canada model].....	250 VA, 205W
[Europe, Australia and General models]	
.....	135W
<RX-385/385 RDS>	
[Canada model] .....	170W
[U.S.A., Australia, Europe, U.K. and	
General models] .....	120W
AC Outlets	
2 SWITCHED OUTLETS	
[U.S.A., Canada, Europe and	
General models].....	100W max. total
1 SWITCHED OUTLET	
[Australia and U.K. models]	
.....	100W max. total
Dimensions (W x H x D)	
.....	435 x 126 x 298 mm
(17-1/8" x 4-15/16" x 11-3/4")	
Weight	
<RX-485 RDS>.....	7.0 kg (15 lbs. 6 oz.)
<RX-385/385 RDS>.....	6.1 kg (13 lbs. 7 oz.)
Accessories.....	AM loop antenna
	Indoor FM antenna
	Remote control transmitter
	Batteries

Specifications are subject to change without notice.



# YAMAHA

---

YAMAHA ELECTRONICS CORPORATION, USA 6660 ORANGETHORPE AVE., BUENA PARK, CALIF. 90620, U.S.A.  
YAMAHA CANADA MUSIC LTD. 135 MILNER AVE., SCARBOROUGH, ONTARIO M1S 3R1, CANADA  
YAMAHA ELECTRONIK EUROPA G.m.b.H. SIEMENSSTR. 22-34, 25462 RELINGEN BEI HAMBURG, F.R. OF GERMANY  
YAMAHA ELECTRONIQUE FRANCE S.A. RUE AMBROISE CROIZAT BP70 CROISSY-BEAUBOURG 77312 MARNE-LA-VALLEE CEDEX02, FRANCE  
YAMAHA ELECTRONICS (UK) LTD. YAMAHA HOUSE, 200 RICKMANSWORTH ROAD WATFORD, HERTS WD1 7JS, ENGLAND  
YAMAHA SCANDINAVIA A.B. J A WETTERGRENS GATA 1, BOX 30053, 400 43 VÄSTRA FRÖLUNDA, SWEDEN  
YAMAHA MUSIC AUSTRALIA PTY, LTD. 17-33 MARKET ST., SOUTH MELBOURNE, 3205 VIC., AUSTRALIA

YAMAHA CORPORATION